

This article was downloaded by:

On: 24 January 2011

Access details: *Access Details: Free Access*

Publisher *Taylor & Francis*

Informa Ltd Registered in England and Wales Registered Number: 1072954 Registered office: Mortimer House, 37-41 Mortimer Street, London W1T 3JH, UK



Journal of Macromolecular Science, Part A

Publication details, including instructions for authors and subscription information:

<http://www.informaworld.com/smpp/title~content=t713597274>

Kinetics and Mechanism of Copolymerization of Linalool with Acrylonitrile

Anjali Shukla^a; A. K. Srivastava^a

^a Department of Chemistry, H. B. Technological Institute, Kanpur, India

Online publication date: 20 February 2003

To cite this Article Shukla, Anjali and Srivastava, A. K.(2003) 'Kinetics and Mechanism of Copolymerization of Linalool with Acrylonitrile', *Journal of Macromolecular Science, Part A*, 40: 1, 61 – 80

To link to this Article: DOI: 10.1081/MA-120016674

URL: <http://dx.doi.org/10.1081/MA-120016674>

PLEASE SCROLL DOWN FOR ARTICLE

Full terms and conditions of use: <http://www.informaworld.com/terms-and-conditions-of-access.pdf>

This article may be used for research, teaching and private study purposes. Any substantial or systematic reproduction, re-distribution, re-selling, loan or sub-licensing, systematic supply or distribution in any form to anyone is expressly forbidden.

The publisher does not give any warranty express or implied or make any representation that the contents will be complete or accurate or up to date. The accuracy of any instructions, formulae and drug doses should be independently verified with primary sources. The publisher shall not be liable for any loss, actions, claims, proceedings, demand or costs or damages whatsoever or howsoever caused arising directly or indirectly in connection with or arising out of the use of this material.



JOURNAL OF MACROMOLECULAR SCIENCE®
Part A—Pure and Applied Chemistry
Vol. 40, No. 1, pp. 61–80, 2003

Kinetics and Mechanism of Copolymerization of Linalool with Acrylonitrile

Anjali Shukla and A. K. Srivastava*

Department of Chemistry, H. B. Technological Institute, Kanpur, India

ABSTRACT

Linalool (LIN) and acrylonitrile (AN) were copolymerized by benzoyl peroxide (BPO) in xylene at 75°C for 60 min. The system follows ideal kinetics with bimolecular termination and results in the formation of an alternating copolymer as evidenced from the values of reactivity ratios as $r_1(\text{AN}) = 0.011$ and $r_2(\text{LIN}) = 0.017$. The overall activation energy is 35.2 kJ/mol. The FTIR spectrum of the copolymer shows the presence of the band at 3467 cm^{-1} due to hydroxy group of LIN and at 2240 cm^{-1} due to a cyanide group of AN. The $^1\text{H-NMR}$ spectrum shows peaks at 7.0–7.7 δ due to alcoholic group of LIN. $^{13}\text{C-NMR}$ spectrum of copolymer has peaks at $\delta\text{ ppm} = 116\text{--}120$ of $-\text{CN}$, and $\delta\text{ ppm} = 75\text{--}77$ of $-\text{C-OH}$. The TGA and DSC studies show that the copolymer is highly stable thermally and has glass transition temperature (T_g) = 50°C. The mechanism of copolymerization has been elucidated. This paper also reports the measurement of Mark Houwink constants in THF at 25°C by means of GPC as $\alpha = 0.50$ and $K = 2.24 \times 10^{-3}\text{ dl/g}$.

Key Words: Copolymerization; Linalool; Acrylonitrile; Mark Houwink constants; Reactivity ratio.

*Correspondence: A. K. Srivastava, Department of Chemistry, H. B. Technological Institute, Kanpur 208002, India; E-mail: akspolym@hotmail.com.

INTRODUCTION

Acrylonitrile copolymerizes readily with electron donor monomers and more than 800 acrylonitrile copolymers have been registered with chemical abstracts. Acrylic monomers have high Q and e values and give highly alternating copolymers with electron donating monomers.^[1,2] Acrylonitrile based copolymers are widely used in the production of acrylic fibers. Polyacrylonitrile fibers suffer from poor hygroscopic and low dye uptake. Suitable comonomers are therefore incorporated into the polymer to overcome these shortcomings.

A search of the literature reveals that a large amount of literature is available on free radical copolymerization, such as ethylene-butadiene,^[3] α -olefin-acrylonitrile,^[4] α -olefin-MMA,^[5] styrene-acrylonitrile,^[6] butadiene-acrylonitrile,^[7,8] but very little attention^[9] has been devoted to the polymerization of acyclic monoterpenoids, as they do not undergo homopolymerization due to steric hindrance,^[10,11] low stabilization energy between monomer and free radicals in transition state,^[12] excessive chain transfer,^[13] termination by cyclization as in case of 1,2 disubstituted ethylenes.^[14]

As functional groups give the polymer structure special character substantially from inherent properties of the basic polymer chain^[15] hence, during the last 25 years, the functional monomers, their homopolymerization and copolymerization behavior and their use in the synthesis of new functional polymers has attracted considerable interest. In recent years some comprehensive work has been published on functional monomers and polymers.^[16-18] Increasing interest in the development of specialty polymers (functional polymers, polymer supports) in recent years has led to a rich arsenal of methodologies and procedures for the laboratory synthesis of functional monomers.

Recently, the polymerization of terpenoids like α/β -pinene^[19-21] has attracted polymer chemists. Therefore, since few terpenoids yield optically active and functional copolymers,^[22] the field of terpenoid polymers is a very challenging area of research with unlimited future prospects.

Linalool, a typical acyclic monoterpene, includes two double bonds and one alcoholic group. It is an optically active unsaturated tertiary alcohol.

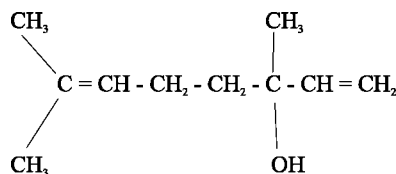

Linalool

Linalool does not undergo homopolymerization; therefore, it is of great interest to investigate the copolymerization of linalool (electron donor monomer) with other suitable comonomers. In the sequence of our lab work,^[23,24] an attempt has been made to study the kinetics, mechanism and characterization of copolymerization of linalool with AN in

**Linalool and Acrylonitrile**

63

xylene initiated by BPO at 75°C. Further, the copolymer formed is significant for functional properties and optical activeness.

EXPERIMENTAL

AN (Merck-Schuchardt) and other solvents were purified by usual methods.^[25] Linalool (B.P. = 196°C; $d_{15}^{\circ} = 0.8621$; $[\alpha] = (-)20.7^{\circ}$ was used after fractional distillation. BPO was recrystallized twice from methanol followed by drying under vacuum.

Polymerization Procedure

A solution containing requisite concentration of linalool with AN in the presence of BPO was polymerized in a dilatometric apparatus (capillary dia. = 4 mm; capillary length = 9.1 cm; lower bulb capacity = 5 ml). The copolymerization runs were performed for 60 min at 75°C in xylene under an inert atmosphere of N₂. The copolymer, precipitated with acidified methanol, was dried to a constant weight. It was then treated with dioxane to remove polyacrylonitrile, but no weight loss was observed. Finally, the copolymer was dried to a constant weight, and percentage conversion was calculated. The rate of copolymerization (Rp) was calculated from the slope of linear plot of % conversion vs. time.

Spectral Measurements

The structure of copolymers were determined by FTIR spectroscopy. The FTIR spectra were recorded with Perkin Elmer 599B spectrometer with KBr pellets. The composition and structure of copolymers were determined by ¹H-NMR and ¹³C-NMR studies, recorded with Varian 100HA Joel LA 400 spectrometer using CDCl₃ as solvent and TMS as internal reference.

Thermal Analysis

The TGA runs were carried out using a V5.1A Dupont 2100 analyzer; sample weight ~ 10 mg. The measurements were carried out at a heating rate 10°C per min up to 500°C. The DSC runs were carried out using V4.0B Dupont 2100 analyzer; sample weight ~ 10 mg, at a heating rate of 25°C per min.

Elemental analysis (% N) was performed on Perkin Elmer elemental analyzer.

GPC studies were made with E. Merck RI-L-7490. The elution solvent was tetrahydrofuran at a temperature of 25°C.

RESULTS AND DISCUSSION

The kinetics of copolymerization has been studied by varying the concentrations of initiator, monomer(s) and temperature. The results have been illustrated in Tables 1 and 2 and Figs. 1–3. The kinetics of copolymerization has been studied by varying [BPO] from 2.3×10^{-3} mol/l to 13.7×10^{-3} mol/l keeping [LIN] and [AN] constant at 0.93 mol/l and 2.5 mol/l, respectively. The reaction proceeds with short induction period of about 3 min. The effect of [BPO] on R_p is shown in Table 1. The R_p increases with increasing concentration of BPO as expected for free radical copolymerization. The order of reaction with respect to [BPO], calculated from the slope of the plot of $\log R_p$ vs. $\log [\text{BPO}]$ (Fig. 1) is 0.5. The plot of $1/[\eta]$ against $[\text{BPO}]^{0.5}$ is linear passing through the origin suggesting a bimolecular mode of termination.

The effect of [LIN] on R_p has been studied by varying [LIN] from 0.18 mol/l to 1.60 mol/l keeping [AN] and [BPO] constant at 2.5 mol/l and 5.5×10^{-3} mol/l, respectively (Table 2). A plot between $\log R_p$ and $\log [\text{LIN}]$ (Fig. 2) is linear, the order of reaction gives the relationship of unity.

The effect of [AN] on R_p has been studied by varying [AN] from 0.5 mol/l to 4.5 mol/l keeping [LIN] and [BPO] constant at 0.93 mol/l and 5.5×10^{-3} mol/l, respectively (Table 2). A plot between $\log R_p$ and $\log [\text{AN}]$ (Fig. 2) is linear, the slope of which gives relationship $R_p \propto [\text{AN}]^{1.0}$.

Effect of Temperature

The rate of copolymerization increases with an increasing temperature and the overall energy of activation is computed as 35.2 kJ/mol from the slope of Arrhenius plot^[26] of $\log R_p$ vs. $1/T$ (Fig. 3).

Table 1. Effect of [BPO] on the rate of copolymerization of LIN and AN.

Sample no.	[BPO] $\times 10^3$ (mol/l)	% conversion	$R_p \times 10^6$ (mol/l/s)
1	2.3	9.7	9.7
2	5.5	13.1	13.8
3	8.2	15.2	15.8
4	11.0	18.4	17.0
5	13.7	21.4	19.1

[LIN] = 0.93 mol/l.

[AN] = 2.5 mol/l.

Copolymerization time = 60 min.

Copolymerization temp. = 75°C.

Table 2. Effect of [comonomer(s)] on the rate of copolymerization of LIN and AN initiated by BPO.

Sample no.	[LIN] (mol/l)	[AN] (mol/l)	% conversion	$R_p \times 10^6$ (mol/l/s)
2	0.93	2.50	13.1	13.8
6	0.93	0.50	8.4	3.8
7	0.93	1.50	11.7	8.1
8	0.93	3.50	16.06	17.3
9	0.93	4.50	18.7	21.3
10	0.18	2.50	10.7	7.4
11	0.55	2.50	12.6	11.1
2	0.93	2.50	13.1	13.8
12	1.3	2.50	17.2	14.1
13	1.6	2.50	19.4	16.4

[BPO] = 5.5×10^{-3} mol/l.

Copolymerization time = 60 min.

Copolymerization temp. = 75°C.

Characterization of Copolymers

In the FTIR spectrum of poly(acrylonitrile),^[27] the absorption band at 530 cm^{-1} is assigned to C–CN. The band at 1230 cm^{-1} is due to the twisting mode of the methylene group ($-\text{CH}_2$) coupled with methine group. The band at 1250 cm^{-1} is assigned to the bending mode of the methine ($-\text{CH}$) group coupled with the rocking mode of the methylene ($-\text{CH}_2$) groups. The bands appearing at 1220–1270; 1345–1375; 1440–1465 cm^{-1} were assigned to C–H vibrations of different modes. A strong band appearing at 2240 cm^{-1} is assigned to $-\text{CN}$. The FTIR spectrum of copolymer (Fig. 4b) shows

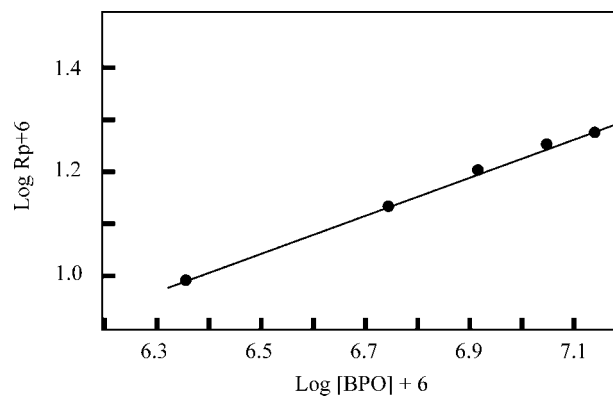
**Figure 1.** Relationship between rate of copolymerization and [BPO] [LIN] = 0.93 mol l^{-1} ; [AN] = 2.5 mol l^{-1} ; copolymerization time = 60 min; copolymerization temp. = 75°C.

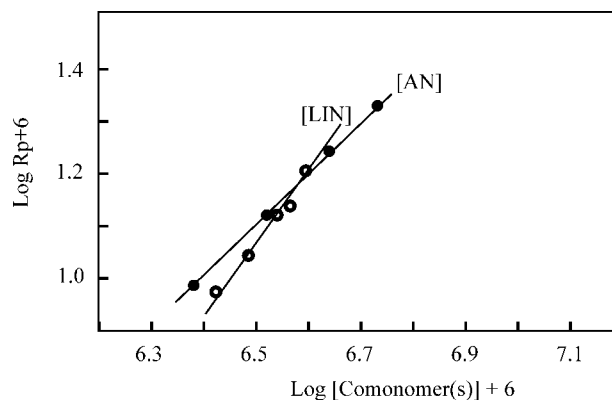

Figure 2. Relationship between rate of copolymerization and [comonomer(s)] [LIN] = 0.93 mol l^{-1} ; [AN] = 2.5 mol l^{-1} ; [BPO] = $5.5 \times 10^{-3} \text{ mol l}^{-1}$; copolymerization time = 60 min; copolymerization temp. = 75°C .

the $-\text{OH}$ bands of hydroxy group of linalool at 3467 cm^{-1} and $-\text{CN}$ group of AN at 2240 cm^{-1} , indicating the incorporation of these monomers in the copolymer.

In the $^1\text{H-NMR}$ spectrum, the chemical shifts of protons attached to elements other than carbon like $-\text{OH}$, $-\text{NH}$, and $-\text{SH}$, to a greater or lesser extent are influenced by related phenomenon of intermolecular exchange and hydrogen bonding. The appearance of signals in the $^1\text{H-NMR}$, due to $-\text{OH}$ protons with the species of small molecular weight, where intermolecular association is not hindered, generally resonates in the region of $3.0\text{--}5.5 \delta$ (hydroxyl proton of CH_3OH appears at 3.3δ whereas that of $\text{C}_2\text{H}_5\text{OH}$ appears at 5.4δ).^[28] However, with many large molecules, the hydroxyl protons often resonates near 8.0δ even at relatively high concentrations, partially because the molar concentration is low and partially due to steric effect,^[29] the $-\text{OH}$ peaks are assigned in the range of $7.0\text{--}7.7 \delta$ in the $^1\text{H-NMR}$ spectra of copolymers of acrylonitrile with linalool (Fig. 5b).

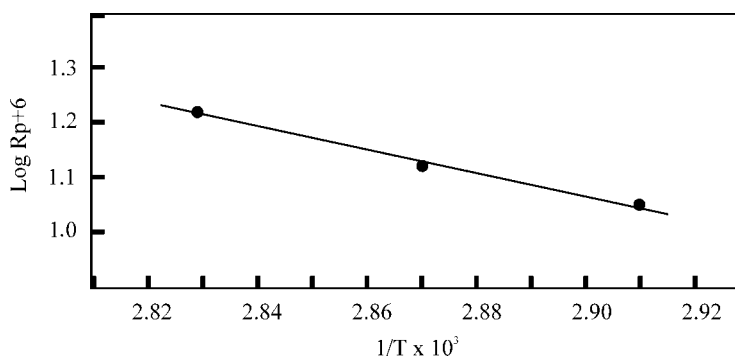

Figure 3. Arrhenius plot of rate of copolymerization vs polymerization temperature [LIN] = 0.93 mol l^{-1} ; [AN] = 2.5 mol l^{-1} ; [BPO] = $5.5 \times 10^{-3} \text{ mol l}^{-1}$; copolymerization time = 60 min.

Linalool and Acrylonitrile

67

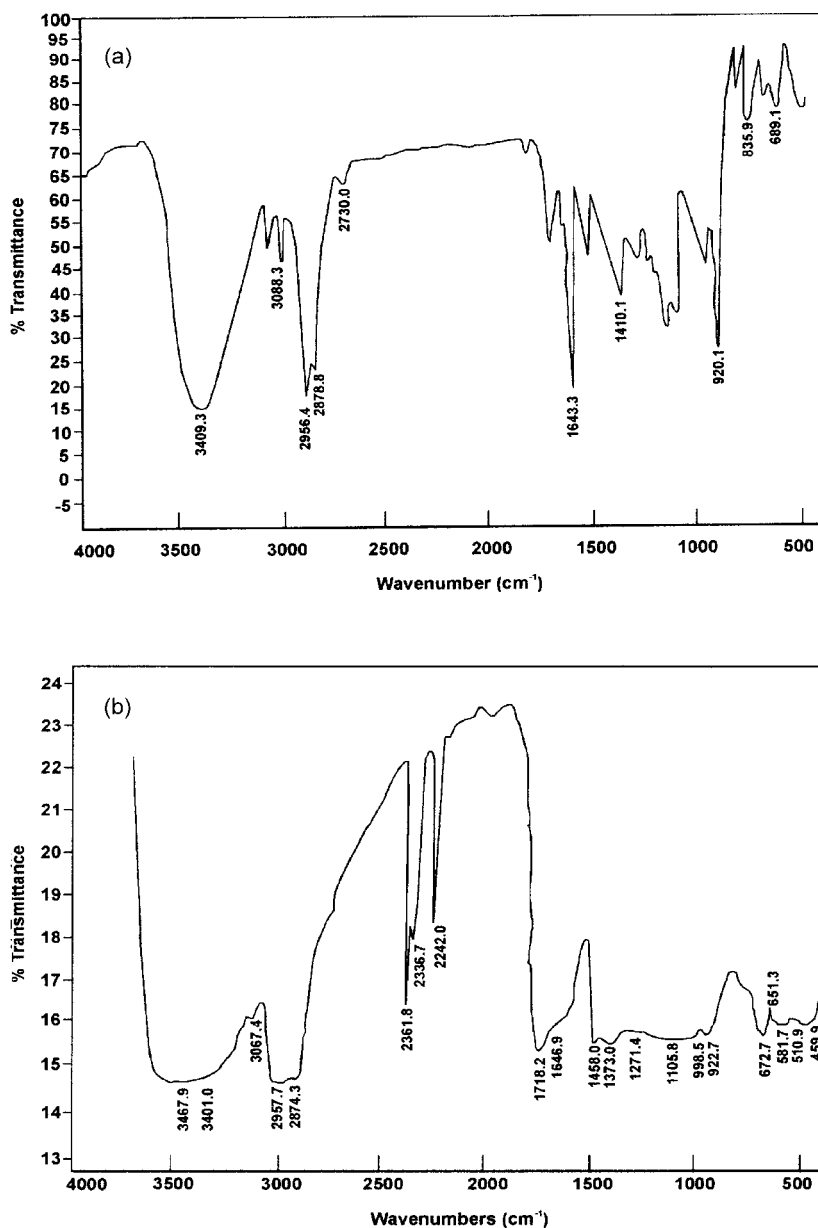

Figure 4. (a) FTIR spectrum of monomer (linalool); (b) FTIR spectrum of copolymer (sample 2).

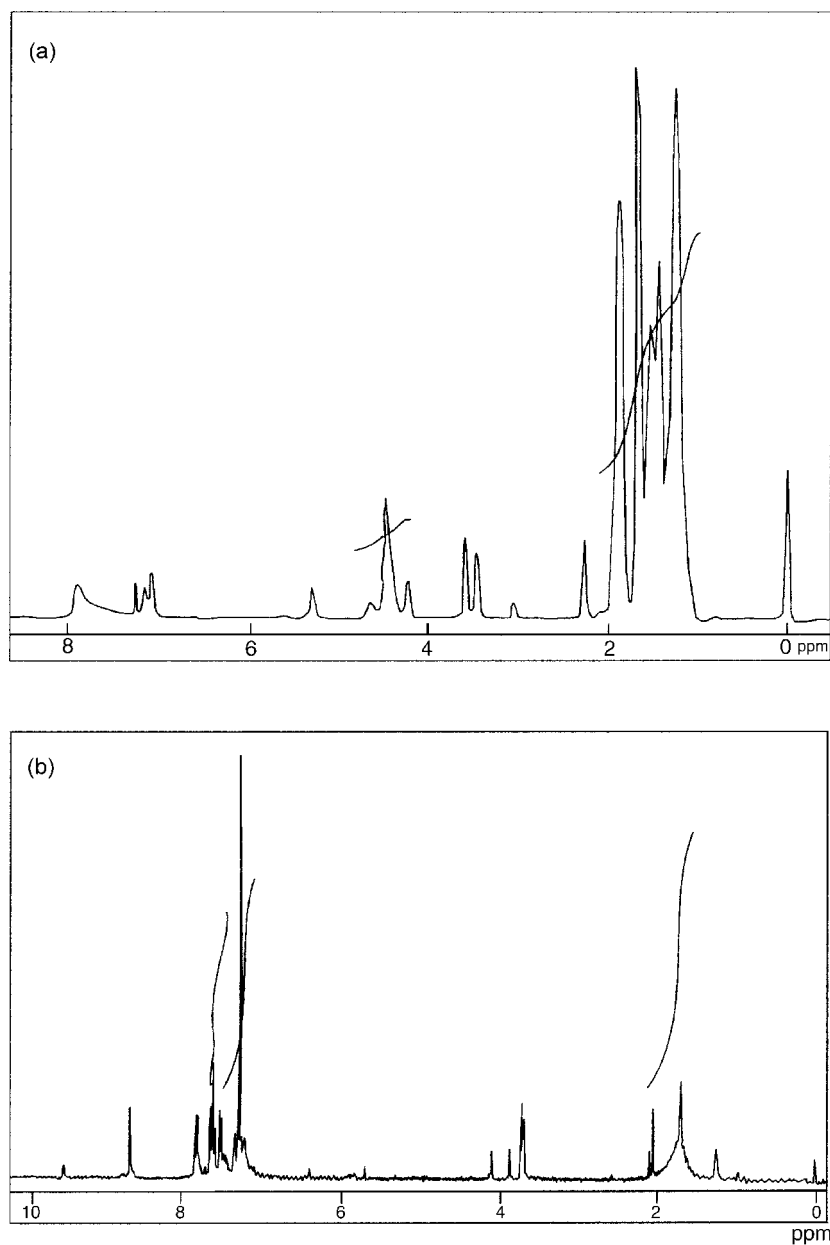
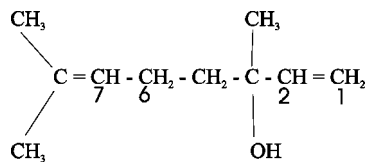

Figure 5. (a) ¹H-NMR spectrum of monomer (linalool); (b) ¹H-NMR spectrum of copolymer (sample 2).

Linalool and Acrylonitrile

69

 $^{13}\text{C-NMR}$ $^{13}\text{C-NMR}$ spectrum of monomer (linalool) (Fig. 6a) shows signals at:

(Structure of Linalool)

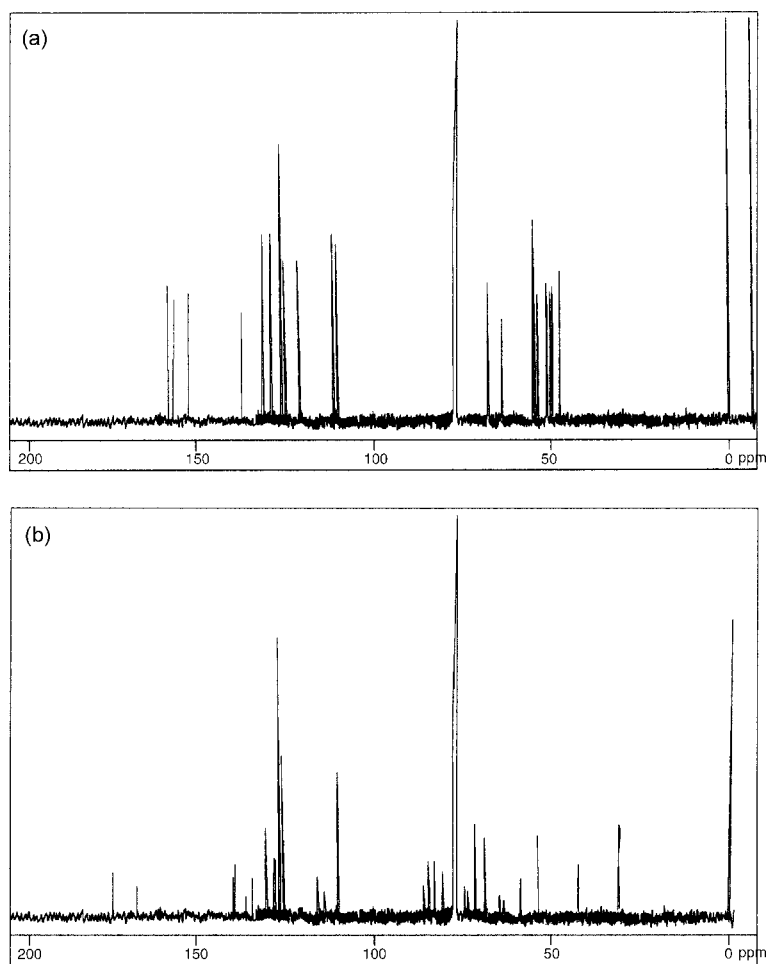

Figure 6. (a) $^{13}\text{C-NMR}$ spectrum of monomer (linalool); (b) $^{13}\text{C-NMR}$ spectrum of copolymer (sample 2).

δ ppm = 137 (C_1); δ ppm = 111.4 (C_2); δ ppm = C–OH = 76.7;

δ ppm = 125 (C_6); δ ppm = 137 (C_7).

^{13}C -NMR spectrum of polyacrylonitrile^[27] shows signals of:

(i) methylene carbon ($-\text{CH}_2-$) appeared at δ ppm = 32–36; (ii) the methine carbon ($-\text{CH}$) giving rise to three well resolved peaks centered at δ ppm = 27–44; (iii) the nitrile carbon ($-\text{CN}$) appeared as a multiplet in the region δ ppm = 116–120.

The ^{13}C -NMR spectrum of copolymer (Fig. 6b) shows two distinct signals:

(i) due to $-\text{C}-\text{OH}$ group of linalool at $\delta = 75-77$ ppm;^[27] (ii) due to $-\text{CN}$ group of AN resonates at $\delta = 116-120$ ppm.

Gel Permeation Chromatography

The Mark Houwink equation $[\eta] = K[M]^\alpha$ relates the intrinsic viscosity $[\eta]$ of a polymer to its molecular weight $[M]$ through empirical constants K and α . The standard procedure of measuring these constants requires \bar{M}_v and $[\eta]$ of polymer samples, which are measured by Gel permeation chromatography (GPC) (Table 3). The two constants α and K of the empirical Mark Houwink expression, were evaluated from the slope and intercept of the plot of $\log \bar{M}$ vs. $\log [\eta]$ (Fig. 7) and the following relationship has been established:

$$[\eta]\text{dl/g} = 2.24 \times 10^{-3} \bar{M}_v^{0.5} \text{ in THF at } 25^\circ\text{C}$$

Differential Scanning Calorimetry

The DSC scans of copolymer samples (Fig. 8) showed a well-pronounced endothermic transition in the temperature range 40–250°C. The values of glass transition temperature (T_g), initial temperature (T_i), onset temperature (T_o) and peak temperature (T_p) of the endotherm for copolymer are shown in Table 4.

The initial temperature (T_i) is the temperature at which the curve deviates from the base line. It is a measure of initiation of the reaction. The onset temperature (T_o) is obtained at the intercept of the tangents to the base line at the lower temperature side of

Table 3. GPC parameters of copolymerization.

Sample no.	$[\eta] \times 10^3$	\bar{M}_n	\bar{M}_v
09	3.98	9807	22609
08	3.17	8813	11220
02	3.09	6969	8709
11	3.02	3847	5248
10	2.95	2980	3090

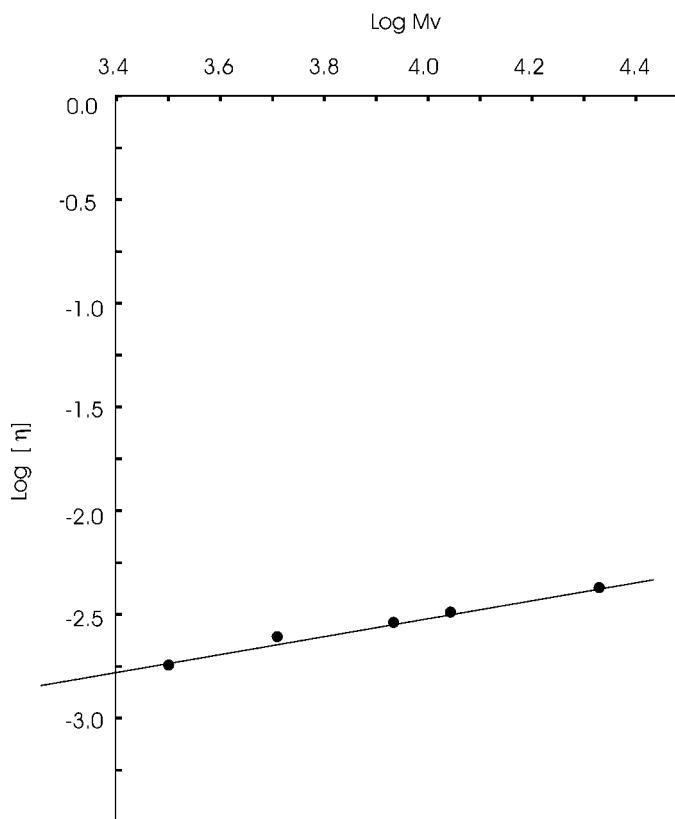

Figure 7. Plot of $[\eta]$ vs. $\log \bar{M}_v$ (Mark Houwink curve). $[\text{LIN}] = 0.93 \text{ mol l}^{-1}$; $[\text{AN}] = 2.5 \text{ mol l}^{-1}$; $[\text{BPO}] = 5.5 \times 10^{-3} \text{ mol l}^{-1}$; copolymerization time = 60 min; copolymerization temp. = 75°C .

the endotherm peak. T_p is the temperature at which the bulk of the copolymer has undergone a dehydration reaction (Sch. 1) and the difference between T_p and T_o ($T_p - T_o$) is the measure of the overall rate of reaction. The smaller the difference, the greater the reaction rate. The DSC studies were also used to determine the enthalpy change as 44.74 J/g .

Grant and Grassie^[30] suggested the anhydride formation in the case of poly methacrylic acid by the dehydration reaction. Likewise, in LIN-AN copolymer, there are three possibilities of dehydration reaction i.e., the elimination of $-\text{H}$ and $-\text{OH}$ groups present to adjacent C-atoms. In these possibilities, the formation of copolymer dehydration product (3) is discarded on the basis that it results in a cumulative system of double bonds and is therefore, unstable.

The possibilities of copolymer dehydration product (1) and (2) may be suggested, as these have a conjugate system of double bonds, and are therefore, more stable. As per Saytzeff's rule, the formation of product (2) is more likely.

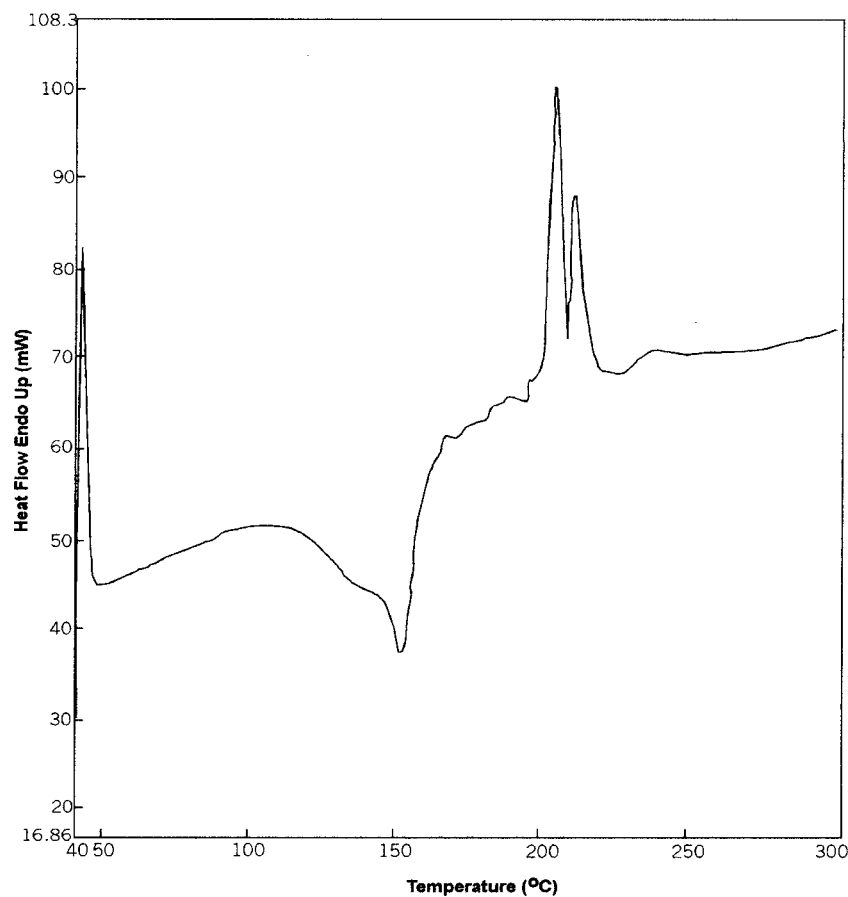

Figure 8. DSC curve of copolymer (sample 2).

Table 4. Thermal analysis data of copolymer (sample no. 4).

T_g (°C)	Endotherm range (°C)		T_o (°C)	T_p (°C)	$T_p - T_o$ (°C)	ΔH (J/g)
	T_i	T_f				
50	199.8	216.8	200	203.33	3.30	44.74

Linalool and Acrylonitrile

73

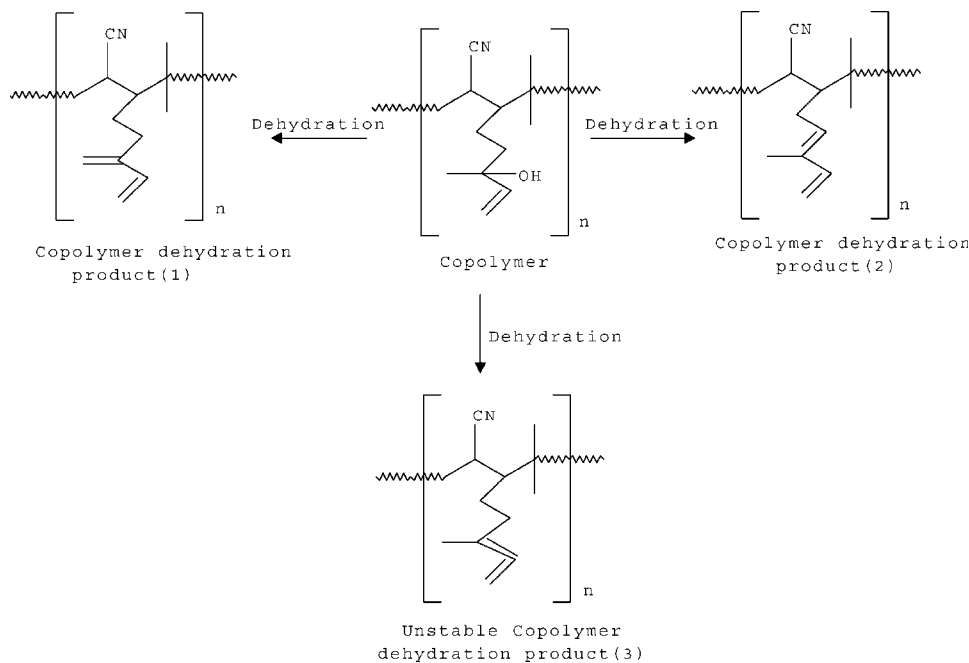
**Scheme 1.** Scheme of dehydration reaction of copolymer.**Thermal Gravimetric Analysis**

The TGA curve for copolymer (Fig. 9) exhibits weight loss with temperature.^[31,32] The thermal behavior data are as follows:

- (a) Onset of major weight loss 377°C; completion of major weight loss occurs at 425°C;
- (b) The total weight loss in the range 39 to 455°C = 95%;
- (c) Weight loss at different stages of temp. are as follows:
 - (i) 25–150°C = 2%
 - (ii) 200–360°C = 4%
 - (iii) 360–455°C = 94.8%
- (d) Almost total volatilization of copolymer occurs at 403°C

Copolymer Composition and Reactivity Ratios

In order to calculate the reactivity ratios, the composition of linalool content (Table 5) has been calculated from the peak area of hydroxy proton of ¹H-NMR and acrylonitrile

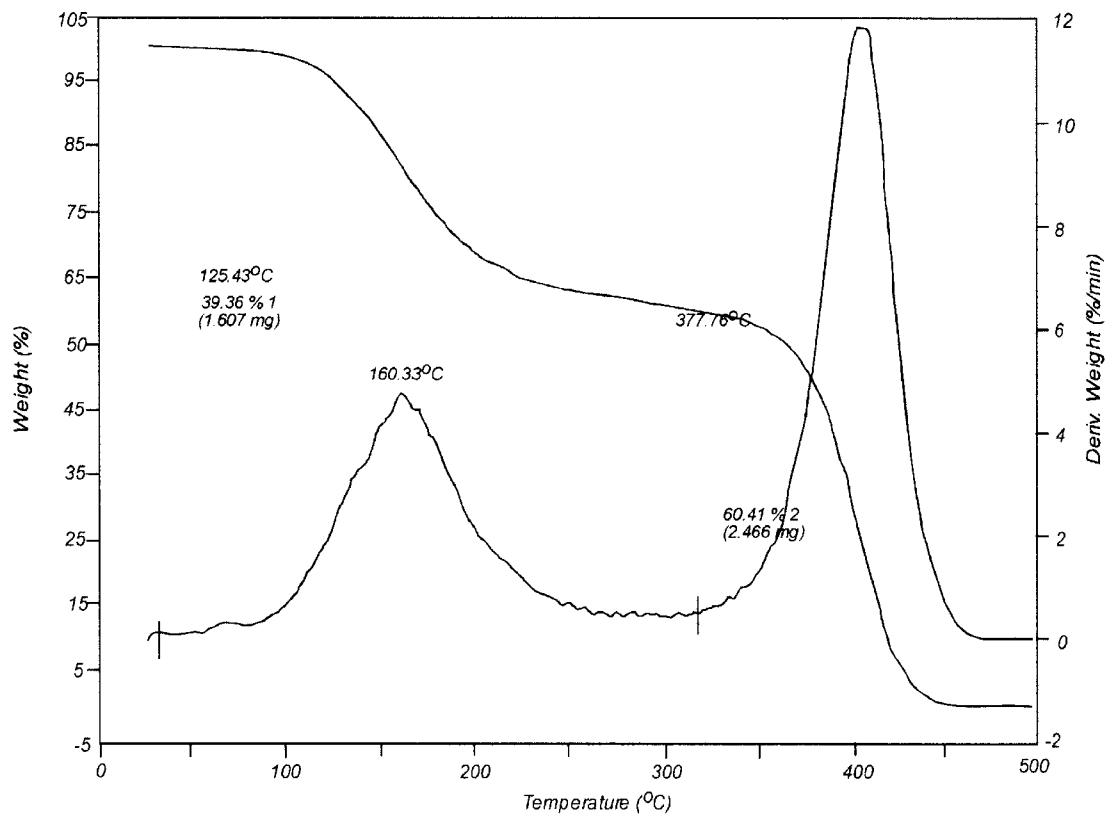

Figure 9. TGA curve of copolymer (sample 2).

Table 5. Composition of copolymer.

Sample no.	Molar ratio in monomer feed [AN]/[LIN]	% conversion	Molar ratio in copolymer composition [AN]/[LIN]
02	2.68	13.10	1.12
07	1.61	11.70	1.14
08	3.76	16.06	1.26
11	4.50	12.60	1.10
12	1.92	17.20	1.04

content from N% by the elemental analysis of the copolymer samples. The values of N% are 8.88%, 7.75%, 11.2%, 4.25%, and 12.66% for the sample no. 2, 7, 8, 11 and 12, respectively. The Kelen Tüdös^[33] approach is used for evaluation of reactivity ratios, $r_1(\text{AN})$ and $r_2(\text{LIN})$ for the monomer according to:

$$\eta = r_1\xi - r_2(1 - \xi)/\alpha$$

where $\eta = G/(\alpha + H)$ and $\xi = H/(\alpha + H)$

The transformed variables G and H are given by:

$$G = \frac{[M_1]/[M_2][(d[M_1]/d[M_2]) - 1]}{d[M_1]/d[M_2]}$$

$$H = \frac{[M_1]/[M_2]^2}{[d[M_1]/d[M_2]}$$

The parameter α is calculated by taking the square root of the product of the lowest and the highest values of H for the copolymerization series. The graphical evaluation for AN/LIN yields values of $r_1 = 0.011$ and $r_2 = 0.017$ (Fig. 10). The product of r_1r_2 is nearly 0, which is the sign of alternating copolymerization.

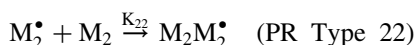
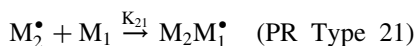
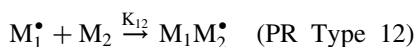
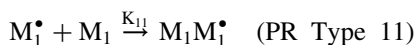

$M_1 = \text{Acrylonitrile}$ and $M_2 = \text{Linalool}$; $r_1 = K_{11}/K_{12}$ and $r_2 = K_{22}/K_{21}$.

By the values of r_1 and r_2 , it is clear that r_1 and r_2 are less than 1 i.e., the propagation reaction type 12 and 21 are preferred to type 11 and 22. The value of r_2 may be taken as zero, which shows that the probability of propagation reaction 22 is much less or somewhat impossible and hence, a chain ending with M_2^\bullet will add only M_1 due to the fact that no homopolymerization of M_2 takes place.

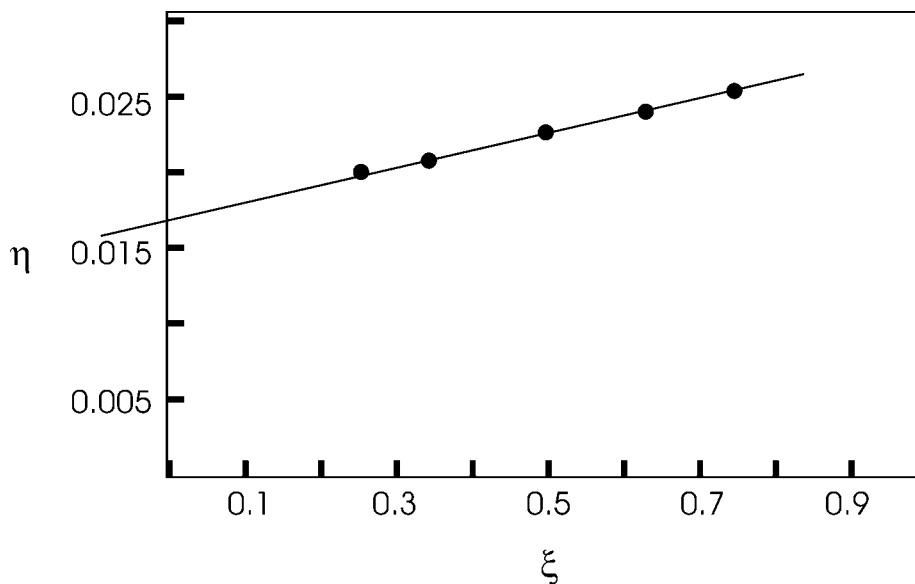
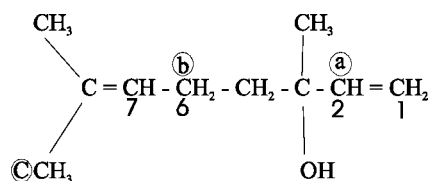

Figure 10. Kelen Tudos plot of copolymer for determination of reactivity ratio.

Mechanism

The $^1\text{H-NMR}$ facilitates the interpretation of the mechanism of copolymerization. The structure of linalool is:



There are two possible sites in the linalool structure for involvement in polymerization; the participation of $>\text{C} = \text{C} <$ bond present between C-1 and C-2 and between C-6 and C-7.

The $^1\text{H-NMR}$ spectrum of linalool (Fig. 5a) shows the peaks of:

- $-\text{CH} = \text{CH}_2$ at 4.1–4.6 δ triplet
- $-\text{CH} = \text{C} <$ at 5.1–5.3 δ triplet
- $-\text{CH}_3 - \text{C} = \text{C} <$ at 1.6 δ singlet

Linalool and Acrylonitrile

77

The $^1\text{H-NMR}$ spectrum of copolymer (Fig. 5b) shows the peaks of:

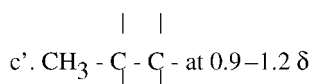
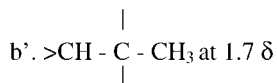
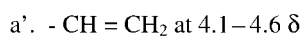

The $^1\text{H-NMR}$ spectrum of copolymer (LIN-AN) shows that $-\text{CH} = \text{C} <$ does not resonate at $5.1-5.3 \delta$, indicating the participation of $>\text{C} = \text{C} <$ bond present between C-6 and C-7 in the copolymerization. Furthermore, the presence of triplet peaks due to $-\text{CH} = \text{CH}_2$ at $4.1-4.6 \delta$ indicates that the $>\text{C} = \text{C} <$ bond present between C-1 and C-2 does not participate in copolymerization. This also indicates that it is unsaturated copolymer. It is further confirmed by the fact that it gives a positive unsaturation test (decolorizes Br_2 water).

Thus, the structure of copolymer may be assigned as below:

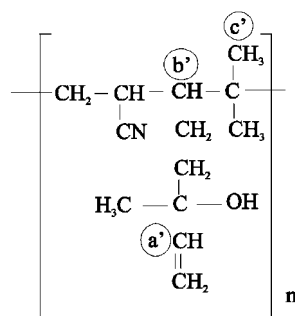

The participation of the double bond in the copolymerization present between C-6 and C-7 is more likely because its homolysis form is a more stable tertiary free radical than the free radical formed by the homolysis of double bond present between C-1 and C-2.

The FTIR spectrum of linalool (Fig. 4a) shows:

- (A) Bands of $\begin{array}{c} \text{CH}_3 \\ | \\ \text{CH}_3 - \text{C} = \text{CH} - \end{array}$ group-
- = C-H stretching at 2971 cm^{-1}
 - $> \text{C} = \text{C} - \text{H}$ stretching at 1668 cm^{-1}
 - C-H bending at 835 cm^{-1}
- (B) Bands of $-\text{CH} = \text{CH}_2$ group-
- = C-C-H stretching at 3086 cm^{-1}
 - $> \text{C} = \text{C} <$ stretching at $1643-1647 \text{ cm}^{-1}$

C-H bending at 996–998 cm^{-1}

The FTIR spectrum of copolymer (Fig. 4b) shows the bands of $-\text{CH}=\text{CH}_2$ group which confirms the formation of unsaturated copolymer.

The proposed mechanism of copolymerization initiated by BPO is as follows:

Initiation:

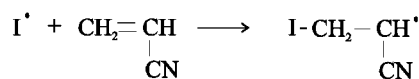
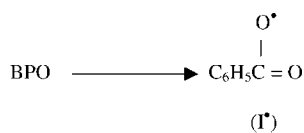

Propagation:

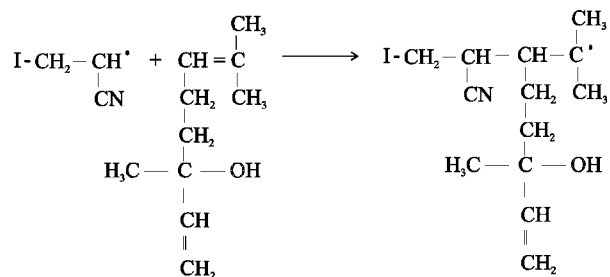

Termination:

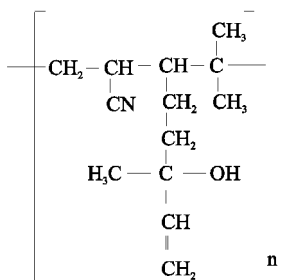
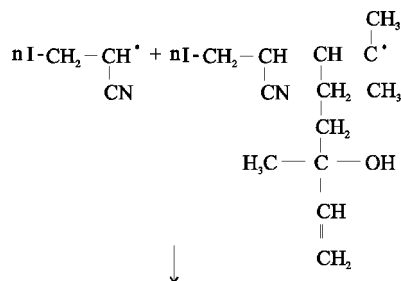

Copolymer



CONCLUSION

Poly(LIN-alt-AN) has been synthesized via free radical solution polymerization using BPO as initiator. It has $T_g = 50^\circ\text{C}$ and Mark Houwink constants $K = 2.24 \times 10^{-3} \text{ dl/g}$ and $\alpha = 0.50$. The copolymer is stable thermally. The system follows ideal kinetics and the energy of activation is evaluated as 35.2 kJ/mole.

ACKNOWLEDGMENT

The authors thank Dr. K. P. Singh, Director, H.B.T.I., Kanpur, for providing the necessary facilities. One of the authors thanks DST, New Delhi, for the sanction of the research project "Synthesis and Characterization of Copolymers of Terpenes with Vinyl Monomers" (SP-S 1-H-26-2000).

REFERENCES

1. Carr, S.H. S.P.E., 35th Annual Technical Conference, Montreal, Quebec., Can. Apr. 25–28. **1977**, 373–375.
2. Stupp, S.I.; Carr, S.H. *Colloid Polym. Sci.* **1979**, 259 (9), 913.
3. Natta, G.; Zambelli, A.; Pasquon, I.; Ciampelli, F. *Makromol. Chem.* **1964**, 79, 161.
4. Miyoshi, K.; Imai, H.; Matsuura, K.; Otsuki, H. Paper presented at the 21st Annual Meeting of the Chemical Society of Japan, Osaka, 1968.
5. Hirooka, M.; Yabuuchi, H.; Morita, S.; Kawasumi, S.; Nakaguchi, K. *J. Polym. Sci.* **1967**, B5, 47.
6. Sanghvi, P.G.; Pokhriyal, N.K. *Polym. Int.* **2001**, 49, 1409.
7. Hirooka, M.; Yabuuchi, H.; Takao, H. Paper presented at the 17th Annual Meeting of the Society of Polymer Sci. of Japan, Tokyo, 1968.
8. Furukawa, J.; Iseda, Y.; Haga, K.; Kataoka, N.; Yoshimoto, T.; Imamura, T.; Shido, Y.; Miyagi, A.; Tanaka, T.; Sakamoto, K. *J. Polym. Sci.* **1969**, B7, 561.
9. Shevtsov, O.K.; Kanevskii, I.M.; Zhukova T.D. (Yarosl Politekh. Inst. Yaroslavl, USSR) *Vysokamol. Soedin. Ser.*, **1957** A25 (7).
10. Ham, G.E. *Copolymerization*; Interscience: New York, 1964.
11. Mayo, F.R.; Lewis, F.M.; Walling, C. *Discussions Faraday Soc.* **1947**, 2, 285.
12. Hayashi, K. *J. Polym. Sci.* **1956**, 20, 537.
13. Joshi, R.M. *Makromol. Chem.* **1962**, 55, 35.
14. Miller, M.L. *The Structure of Polymers*. Reinhold Publishing Corporation: London, 1968; 450.
15. Vogl, O. *J. Macromol. Sci., Pure Appl. Chem.* **1996**, A33, 963.
16. Arshady, R. *J. Macromol. Sci., Rev. Macromol. Chem. Phys.* **1992**, C32, 10.
17. Akelah, A.; Moet, A. *Functionalized Polymers and Their Applications*; Thomson Press (India) Ltd.: New Delhi, 1990.
18. Bicak, N.; Senkal, B.F. *React. Funct. Polym.* **1996**, 29, 123.
19. Jiang, D.T.; Shaoru, N.; Mitchell, A.W. *Macromolecules* **2000**, 33, 1482.
20. Hou, S.J.; Gong, X.; Chan, W.K. *Macromol. Chem. Phys.* **1999**, 200 (1), 100.



21. Doiuchi, T.; Yamanguchi, H.; Minoura, Y. *Eur. Polym. J.* **1981**, *17* (9), 961.
22. Tocker, S. *Makromol. Chem.* **1967**, *101*, 23.
23. Pandey, P.; Srivastava, A.K. *J. Polym. Res.* *in press*.
24. Pandey, P.; Srivastava, A.K. *Polym. Int.* **2001**, *50*, 937.
25. Vogel, A.I. *A Text Book of Practical Org. Chem.*, 5th Ed.; Longmann: London, 1994; 395.
26. Bhatnagar, U.; Srivastava, A.K. *Polym. Int.* **1991**, *25*, 13.
27. Bajaj, P.; Sen, K.; Bahrami, S.H. *J. Appl. Polym. Sci.* **1996**, *59*, 1539.
28. Dyer, J.R. *Applications of Absorption Spectroscopy of Organic Compounds*, 10th Ed.; Prentice Hall International, Inc., 1997; 66.
29. Jackman, L.M.; Sternhell, S. *Application of Nuclear Magnetic Resonance Spectroscopy in Org. Chem.*, 2nd Ed.; Pergamon Press: London, 1985; 215.
30. Grant, D.H.; Grassie, N.J. *Polymer* **1960**, *1*, 125.
31. Gronowski, A.; Wojtczak, Z.J. *Therm. Anal.* **1983**, *26*, 233.
32. Balcerowiak, W.; Hetper, J.; Beres, J.; Olkowska, J. *J. Therm. Anal.* **1977**, *11*, 101.
33. Kelen, T.; Tudos, F. *J. Macromol. Sci., Chem. Ed.* **1975**, *A9*, 1.

Received January 5, 2002

Revised May 13, 2002